

## 6.0 Reset (627, 631, 637)

When removing the brace, always replace **Pull Tabs D** to ready position (6.1). Lay brace on a flat surface **C** then pull both Wings outward to reset the tightening mechanism (6.2).

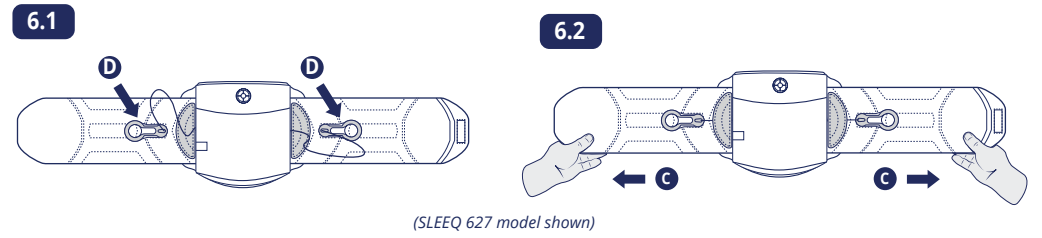

## 7.0 Customizations (627, 631, 637)

**7.1 WING PANEL CUSTOMIZATION:** (Note: Additional customization can be added to the wings as needed)

Follow instructions **5.1 5.2** to access wing assembly

**7.2** (1) Open wing pocket (2) Remove and customize the felt wing panel (W)

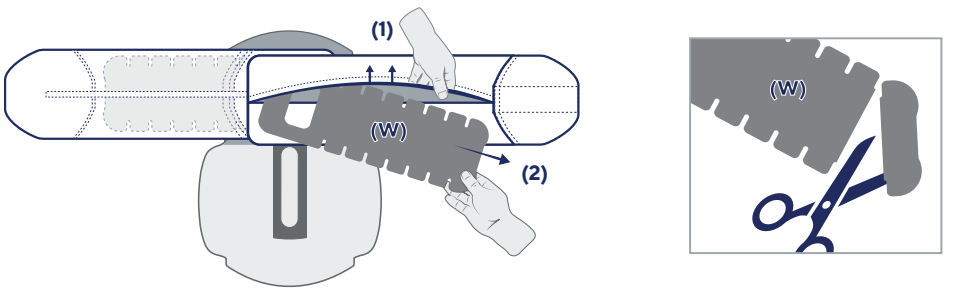

**7.3** Reverse steps to re-assemble  
(Note: Rectangle cutout on felt panel should be positioned medial to both wing extensions)

**7.4 INTERIOR PANEL CUSTOMIZATION:**  
Anterior Panel (A) and the Back Panels (T), (L) can be heat modified, trimmed and/or custom contoured

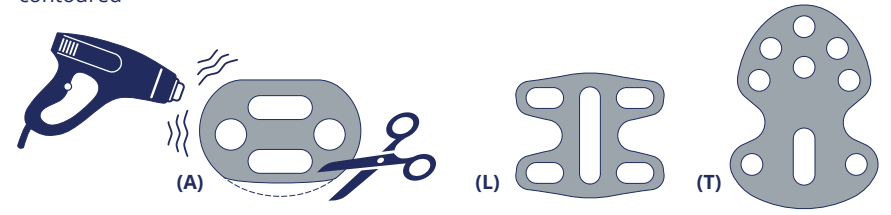

**MATERIAL CONTENT:**  
Nylon, Polyethylene, Polyester, Ether Foam, ABS, Latex Free Synthetic Rubber



**LIMITED WARRANTY**  
Thuasne USA warrants to the original purchaser that this product is free from defects in materials and workmanship. Normal wear and tear during the use of a product is not considered a defect. This Limited Warranty is effective from the date of delivery to the original purchaser for up to 6 months. This warranty does not apply if this product; (1) has been altered in any way; (2) was not purchased from Thuasne USA or one of its authorized distributors; (3) is not used in accordance with Thuasne USA's Instructions for Use (IFU). Under this Limited Warranty Thuasne USA's sole obligation shall be to repair or replace the defective product or associated part(s) at no charge. This Limited Warranty does not cover damage as a result of mishandling, accidents, improper use or alteration of the product. This warranty is in place of all other warranties, either express or implied, including but not limited to warranties of merchantability or fitness for a particular purpose. Thuasne USA shall not be liable under this or any implied warranty for any personal injury, property damage, or special, incidental, or consequential damages arising out of, related, or incidental to the use of the product even if Thuasne USA has been informed of the prospect of such possible loss or damage, unless state law otherwise prohibits this exclusion. User should seek advice from their healthcare provider immediately if user encounters any kind of adverse reaction related to the use of this product. User should consult with their healthcare provider with any questions or concerns relating to the proper use of this product for their specific medical condition. **IMPORTANT-** Read all Instructions for Use (IFU) and any other associated materials to ensure proper use.



**SLEEQ<sup>®</sup> ADAPT**  
Premium lumbar-sacral orthosis

### INSTRUCTIONS FOR USE

- 627** Low-profile sagittal (anterior-posterior) control lumbar orthosis.
- 631** Enhanced-profile sagittal (anterior-posterior) control lumbar-sacral orthosis.
- 637** Enhanced-profile sagittal-coronal (anterior-posterior-lateral) control lumbar-sacral orthosis.



4615 Shepard Street, Bakersfield CA 93313 800.432.3466



# SLEEQ<sup>®</sup> ADAPT L50

These instructions are guidelines for use only and are not offered as medical recommendations. PERMANENT INJURY MAY RESULT FROM USE OTHER THAN AS DIRECTED BY A PHYSICIAN OR OTHER MEDICAL AUTHORITY. THUASNE SPECIFICALLY DISCLAIMS ANY OBLIGATION OR LIABILITY FOR INJURY OR DAMAGE BY REASON OF ANY APPLICATION OF THIS PRODUCT. PLEASE SEE THE LIMITED WARRANTY FOR FURTHER INFORMATION IN THIS REGARD.

## INDICATIONS:

Low back support, Sagittal plane motion restriction (and coronal plane motion restriction on 637), Increased intracavitary pressure to reduce spine and disc loading, Acute and/or chronic low back and lower extremity pain (sciatica), Post-operative spinal procedures, Post-injury to facilitate healing

## CONTRAINDICATIONS:

Pregnancy, Circulatory, pulmonary, cardiovascular or other conditions where increased abdominal pressure would be of concern, Unstable vertebral fracture, Known allergy to product component, Abdominal size more than 59in (150cm) for brace fitting (see size guide)

## INTENDED CLINICAL BENEFITS:

Provide motion restriction and support to the mid and lower spine to reduce pain, post-operative and post-injury stabilization

## WARNINGS & PRECAUTIONS:

Read all instructions prior to use, If increased pain, swelling, sensation changes, or any adverse reactions are experienced while using this product, immediately consult your medical professional. For single patient use only. This product is intended to be applied by qualified clinician as directed by a physician or other qualified healthcare practitioner.

## 1.0 BRACE COMPONENTS (627, 631, 637)

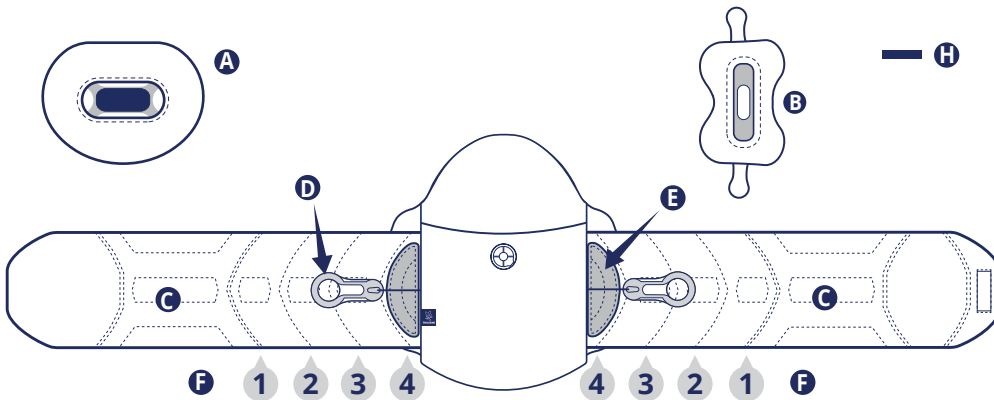

IN.	26 - 32	32 - 38	38 - 44	44 - 54	G	110 - 136	95 - 110	80 - 95	65 - 80	CM.
					↕					

- A.** Anterior panel
- B.** Lateral Panel (637 only)
- C.** Wing
- D.** Pull Tab
- E.** Hook Crescent Connector
- F.** Sizing Arc indicator
- G.** Sizing Guide
- H.** Hook tab (for step down 6.3)

## 2.0 SIZING (627, 631, 637)

**2.1** Measure waist circumference and see Sizing Guide (G).

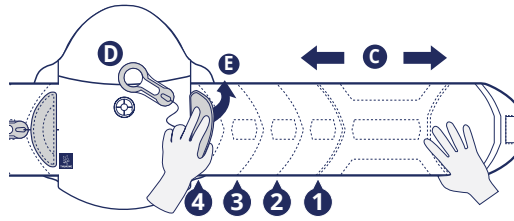

**2.2** ADJUST BRACE:

- Detach Pull Tab (D) from wing (C).
- Lift Crescent Connector (E) slide wing (C) to numbered sizing arc.
- Press Down Crescent Connector (E) to secure.
- Replace Pull Tab (D) into ready position (see 7.1).
- Repeat on opposite wing.

## 3.0 ATTACH ANTERIOR PANEL (627, 631, 637) & LATERAL PANELS (637 only)

- 3.1**
- Attach Anterior Panel (A)
  - Align Lateral Panel (B) (APL only) to same sew line arcs on both wings.
  - Attach Velcro Tabs (B) to wing.

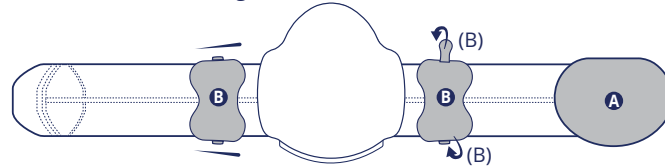

## 4.0 APPLICATION (627, 631, 637)

**4.1** Position brace at coccyx level.

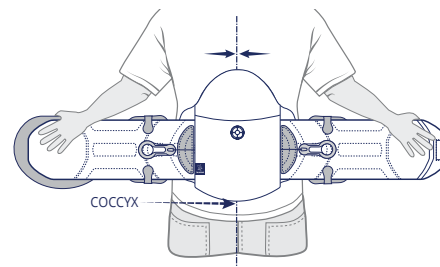

**4.2**

- Position Anterior Panel (A).
- Wrap wing (1)
- Wrap wing (2) and secure Velcro.

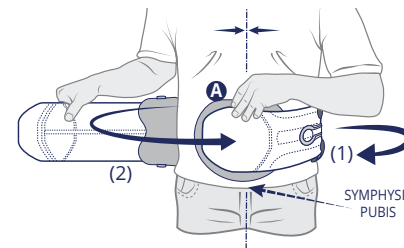

**4.3** TIGHTEN BRACE: Detach pull-tabs (D) move anteriorly and re-attach.

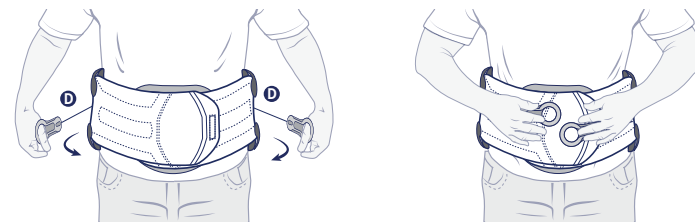

## 5.0 Custom Fit Modifications (627, 631, 637)

**5.1** ACCESSING BACK PANEL: Separate cover at base

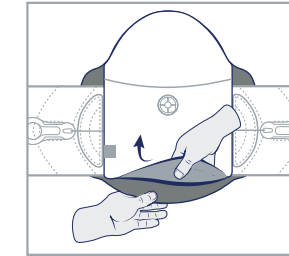

**5.2** (1) Flip up wing assembly (2) Fold down flap (3) Remove or replace plastic panels.

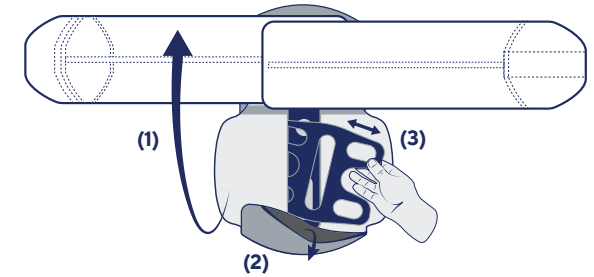

**5.3** BACK PANEL STEP DOWN (631, 637 only): Complete steps (5.1) (5.2) Remove panel (T) and replace panel (L), Remove tab (H) (save)

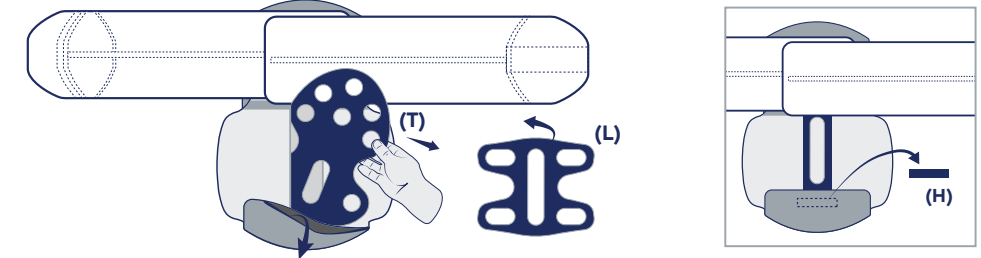

**5.4** Fold down wing assembly

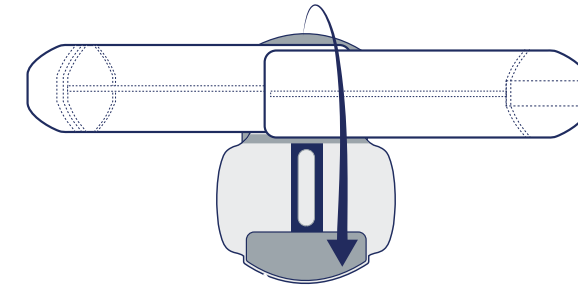

**5.5** Fold excess material inside panel, away from patient

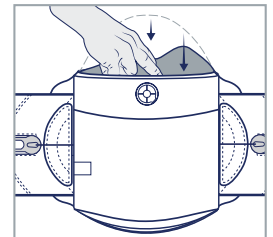

Attach tab (H) inside pocket and press sides together

**5.6** Final step-down from 631, 637 to 627

